

THE HEIGHT OF PERFECTION



**SECURITY
CHIMNEYS**

PRODUCT DIRECTORY

Secure Temp™ ASHT+

**HIGH-TEMPERATURE
FACTORY-BUILT
CHIMNEY**



REACHING NEW HEIGHTS

Five decades of proven
quality and innovation.

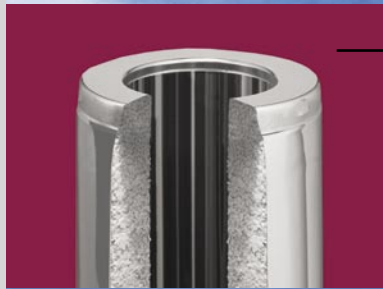

Innovative design

Security chimneys are made of stainless steel for outstanding resistance to corrosion and feature exclusive Secura Plus-2 insulation for minimum heat loss. These new Security chimneys are also 25% lighter!



Easy to install

Security chimneys feature a fast and easy Twist-Lock assembly. This system keeps installation time to a minimum. No additional part is needed!



A real beauty

High quality 400-series stainless steel selected for its outstanding resistance and astonishing look. What a beauty!



Everything you need

Security Chimneys International offers a wide variety of universal accessories that add beauty and simplicity to every installation. From insulated attic and wall radiation shields to wall bands and roof supports that fit 5, 6, 7, 8 and 10" I.D. That means less SKUs!



Lifetime Warranty

Security Chimneys International guarantees their stainless steel chimneys for an unlimited time from the date of purchase against chimney fires and corrosion.

TABLE OF CONTENTS

The Security Chimneys International line of venting products and fireplaces has benefitted from continuous improvement to make it a household name for over 50 years.

| Subject | Page |
|---|--------------|
| Technical Data | 4-5 |
| Field of application | 4 |
| Design | 4 |
| Composition | 4 |
| Insulation | 4 |
| Installation (general info) | 4 |
| Certification | 4 |
| Warranty | 4 |
| Installation Information | 6-7 |
| Installation | 6 |
| Safety | 6 |
| Support | 6 |
| Offset | 6 |
| Connection | 6 |
| Chimney sizing | 6 |
| Masonry renovation | 6 |
| Stability | 6 |
| Watertightness on the roof | 6 |
| Termination | 6 |
| Charts | 7 |
| Typical Installations | 8-9 |
| On a stove in a chase | 8 |
| On a stove with finishing support | 8 |
| To a furnace (interior installation) | 9 |
| On a stove in mobile home | 9 |
| Product Specifications | 10-18 |

**HIGH-TEMPERATURE
FACTORY-BUILT
CHIMNEY**

Continuous improvement has made Security Chimneys International a household name for over 50 years – and a manufacturer of one of the most popular lines of venting products in North America.

One example of this continuous improvement is our Secure Temp™ASHT+ high-temperature chimney, a high-quality product offering maximum protection and capable of reaching temperatures of 2100°F.

Field of application

Security Chimneys International's Secure Temp™ ASHT+ high-temperature chimney has been designed for residential applications.

Specially developed for use with oil, gas and coal appliances, plus controlled-combustion stoves and wood-burning fireplaces, the Secure Temp™ ASHT+ high-temperature chimney has been listed to UL-103HT standards at 2100°F and is available in diameters of 5, 6, 7, 8 and 10 inches.

Design

The Secure Temp™ ASHT+ high-temperature chimney is a double-wall all stainless steel chimney. The exclusive Secura Plus-2 insulation minimizes heat loss through the chimney walls. The external casing of the Secure Temp™ ASHT+ carries the structural load. A free-floating inner lining is attached only to the male coupler at the top, expanding and contracting freely with temperature fluctuations.

Composition

Selected stainless steel The use of various gauges of stainless steel selected for their resistance to high temperatures and corrosion lends outstanding durability to the Secure Temp™ ASHT+ high-temperature chimney. Now available: aluminum-zinc coated steel casing in 6, 7, and 8 inch I.D.

Insulation

The Secure Temp™ ASHT+ high-temperature chimney is lined with exclusive, superior quality high-density Secura Plus-2 insulation. Chimneys in diameters of 5 to 10 inches feature one inch of insulation.

This exclusive insulation keeps the temperature of the outer casing relatively low. All Secure Temp™ ASHT+ high-temperature chimneys, regardless of diameter, can be installed as close as 2 inches from combustible materials. Moreover, this insulation makes it possible to keep safety features as simple as possible.

Installation

The Secure Temp™ ASHT+ high-temperature chimney (5 to 10 inch diameters) features fast and easy Twist-Lock assembly. Lengths and universal fittings fit together and lock into place by twisting one-eighth of a turn. No other part is needed to ensure the chimney's structural stability. This system keeps installation time to a minimum.

Field of application

The Secure Temp™ ASHT+ high-temperature chimney is certified by Intertek Testing (Warnock Hersey) to HT standards for all diameters of 5, 6, 7, 8 and 10 inches.
• Tested to UL-103HT

| Temperature | Period |
|-------------|-------------------------------------|
| 1000°F | 6 to 7 hours |
| 1400°F | 1 hour |
| 2100°F | 3 x 10 minutes, brief forced firing |

Design

Security Chimneys International Ltd. warrants its factory-built Secure Temp™ ASHT+ stainless steel chimney for an unlimited time from the date of purchase. This warranty is limited to the replacement of chimney components provided it has been properly installed and used as intended. This warranty cannot be extended by our representatives, written information or drawings.

Secure Temp™ ASHT+ (HT Type)

| Ø int. | Ø ext. | Insulation thickness (in.) | Weight in lb./ft. | Twist-Lock assembly | Clearance to combustible (in.) |
|--------|--------|----------------------------|-------------------|---------------------|--------------------------------|
| 5 | 7 | 1 | 4.1 | YES | 2 |
| 6 | 8 | 1 | 5.2 | YES | 2 |
| 7 | 9 | 1 | 6.4 | YES | 2 |
| 8 | 10 | 1 | 7.2 | YES | 2 |
| 10 | 12 | 1 | 8.9 | YES | 2 |

*Lengths produced may have a weight variance of approximately 10% compared to the above listing.

HIGH-TEMPERATURE FACTORY-BUILT CHIMNEY

The arrival of controlled-combustion stoves led to the development of Security's Secure Temp™ ASHT+ high-temperature chimney. The ASHT+ was the first chimney listed to standards established for temperatures of 2100°F when used with this type of appliance.

Controlled-combustion units more easily produce creosote build-up in the chimney because combustion control limits the oxygen that feeds the fire. The resulting creosote build-up can cause fires capable of reaching temperatures of up to 2100°F.



Coupler system for fast assembly

The SecureTemp™ ASHT+ features an assembly system lending itself to fast and easy installation. No screws or other attachments are required.

HT TYPE

5" to 10"

1/8th turn

Twist-Lock assembly

Overlap: 1 3/16"

Stainless steel inner lining with low reaction to heat

Thin inner lining for immediate heating. Smooth surface: very slight heat loss to flue gases, possible offset up to 30°.

Outstanding corrosion resistance.

Exclusive SECURA PLUS-2 insulation

No shifting of the insulation.

Minimal cooling of gas temperature, which stabilizes at high levels.

Reduction of condensation and creosote build-up. Avoids corrosion caused by acid condensation.

Fast venting of combustion products

Stable and powerful draft.

Outer casing

Supports the structural load.

Low surface temperature.

Minimum 2" safety clearance from combustible materials in diameters of 5" to 10".

Inner liner unattached to the female coupler

Free-floating inner wall – no need for expansion joints.

Unhindered expansion with rising temperatures.

Lightweight

6" diameter – 5.2 lb. per linear foot.

User friendly.

For support, see "Loadbearing Capacity" chart.

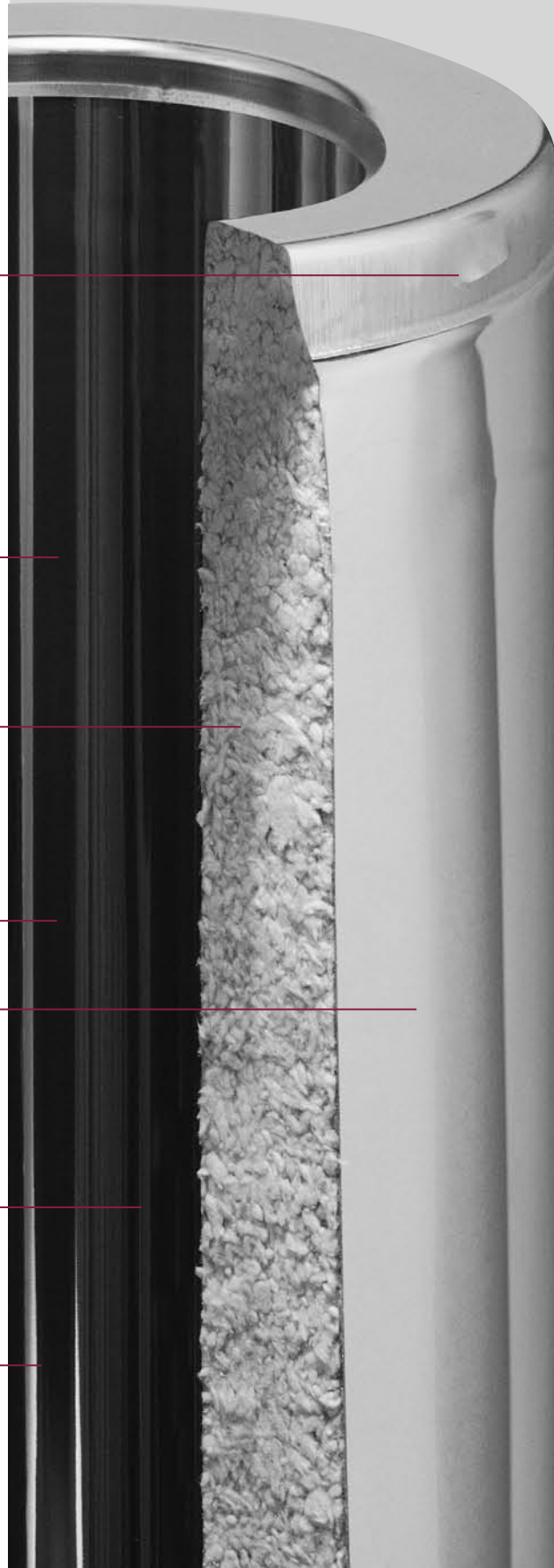

Installation

Assembly always requires the male coupler to be positioned upwards.

Size the chimney in accordance with the appliance instruction manual.

Prior to installation, consult the detailed installation manual included with the **Secure Temp™ASHT+** support.

Safety

The **Secure Temp™ASHT+** high-temperature chimney can be installed 2 inches from combustible materials, regardless of the diameter used. The use of fire-stop spacers and radiation shields automatically maintains the correct clearance as the chimney passes through floors and combustible partitions.

Some radiation shields in the **Secure Temp™ASHT+** high-temperature line have been designed specifically for use with wood-burning fireplaces. They are certified for use with Security Fireplace products.

For the use of **Secure Temp™ ASHT+** with other manufactured fireplaces, refer to the certification of these products. Available in diameters of 7, 8 and 10 inches only.

As several radiation shields are available, consult the section on Firestops for specific uses.

Support

Different types of supports are available to meet the requirements of various types of installation. When the height of the installation exceeds the load-bearing capacity, use additional support.

- base support
- wall support
- adjustable wall support
- roof support
- offset support
- cathedral support
- square cathedral support
- finish support
- adjustable square support

Offset

15° or 30° elbows are available to offset the **Secure Temp™ASHT+** chimney. A maximum offset of 30° is allowed. Two offsets (total of 4 elbows) per installation are permitted.

Connection

The use of a 90° insulated tee allows the lateral connection of a heating appliance to a vertical chimney. It can be used to pass through a wall or at the base of an interior installation. It can provide access for inspection or cleaning purposes, and can be fitted with an insulated tee cap or drain tee cap.

A base tee for indoor use facilitates chimney inspection and cleaning. Available in galvanized steel, it provides the necessary clearance for the connection of a simple black pipe length. A base tee with two openings is also available for connecting two appliances (not when burning wood).

Tees come with a tee cap.

Chimney sizing

A chimney must be well-suited to the requirements of the appliance in terms of geometric profile and combustion parameters.

Most stoves use a stove connector, such as Security Chimney International's double-wall black pipe with Twist-Lock system.

Fireplaces certified for use with the **Secure Temp™ASHT+** can be installed directly on top of the unit. For other fireplaces, an anchor plate is available.

All other connections to appliances can be made using an extension length. This component attaches to the female coupler of the last section.

Stability

a) Vertical installation

Universal wall bands ensure the stability of a **Secure Temp™ASHT+** high-temperature chimney. While these bands are not loadbearing components, they are necessary to ensure the chimney's lateral stability. They should be used every 8 feet with a regular wall band or every 10 feet if a reinforced wall band is used.

Also available is a wall band extension, which is used in combination with a reinforced wall band to extend the clearance between the chimney and wall surface by 2 to 4 inches.

b) Chimney through the roof

No support is required for free-standing chimneys extending up to 5 feet beyond the roof line in areas subject to normal weather conditions.

* Roof brace (0 to 9 feet)

Used in areas subject to high winds, to stabilize the chimney or on sloped roofs, to stabilize chimneys between 5 and 9 feet beyond the roof.

Adjustable braces adapt to the slope of the roof (from 60 to 115 inches).

* Guy wire band (5 to 13 feet)

Beyond 5 feet, to a maximum height of 13 feet, the chimney can be stabilized using guy wire bands.

Watertightness on the roof

When the chimney passes through the roof, a flashing with radiation shields (4) attached to the joists is required. Several types of flashings are available to adapt to the full range of roof pitches.

Six types of flashing are offered:

- flat roof flashing
- adjustable roof flashing for sloped roofs 1/12 to 7/12
- adjustable roof flashing for sloped roofs 8/12 to 12/12
- adjustable roof flashing for sloped roofs 12/12 to 21/12
- adjustable roof flashing for peaked roofs 1/12 to 7/12 (6" to 10" only)
- adjustable roof flashing for peaked roofs 7/12 to 12/12 (6" to 10" only)

Mobile homes require the installation of a vented roof flashing.

Each flashing comes with a storm collar.

Termination

A termination cap must be installed at the top of the chimney. Our rain cap is offered in 5 to 10 inch sizes. We recommend that a spark arrester band be installed to eliminate sparks from falling on the roof.

Loadbearing Capacity

| Ø int. | Maximum height in feet | | | | |
|--|------------------------|----|----|----|-----|
| | 5" | 6" | 7" | 8" | 10" |
| Supports | SecureTemp™ ASHT+ | | | | |
| Base support | 32 | 32 | 32 | 32 | 32 |
| Wall support | 63 | 63 | 55 | 48 | 39 |
| Adjust. wall support | 63 | 63 | 55 | 48 | 39 |
| Roof support | 42 | 34 | 27 | 24 | 20 |
| Offset support | | 28 | 24 | 20 | 14 |
| Sq. Cathedral support | | 60 | 50 | 45 | 35 |
| Finishing support | | 75 | 65 | 59 | |
| Adjustable Square support w/framing arms and coupler | | | 27 | | 22 |

Size of Openings*

| Ø int. | Maximum height in feet | | | | |
|------------------------|------------------------|--------|--------|--------|--------|
| | 5" | 6" | 7" | 8" | 10" |
| Supports | SecureTemp™ ASHT+ | | | | |
| Base support | 14-3/8 | 14-3/8 | 14-3/8 | 14-3/8 | 14-3/8 |
| Sq. Cathedral support* | 14-3/8 | 14-3/8 | 14-3/8 | 14-3/8 | 14-3/8 |
| Finish support | 14-3/8 | 14-3/8 | 14-3/8 | 14-3/8 | |
| Roof support* | 11-3/8 | 12-3/8 | 13-3/8 | 14-3/8 | 16-3/8 |
| Radiation shield | 11-3/8 | 12-3/8 | 13-3/8 | 14-3/8 | 16-3/8 |
| Firestop (BF) | 11-3/8 | 12-3/8 | 13-3/8 | 14-3/8 | 16-3/8 |

* The size of the opening may vary depending on the pitch of the roof.

Chart for the selection of lengths

These charts will make it easier for you to calculate the exact height in effective lengths of the chimney installation. It will enable you to deduct the value of the overlaps. Consult the chart that corresponds to the type of installation you are planning. Follow the steps presented below:

- Determine the height of the installation.
E.g. 32 feet.
- Determine the combination of lengths required to reach this height.
E.g. 10 X L36 = 30 feet + L24 = 32 feet
- Calculate the number of sections used and deduct ONE value to obtain the number of overlaps involved.
E.g. 11 sections - 1 = 10 overlaps
- Consult the charts to obtain the height to be deducted due to the overlaps.
E.g. 32 feet - 11-7/8 in. = 31 ft. 1/8 in.

If necessary, complete your installation by adding one of the following lengths.

Lengths available: L8, L12, L24, L36

A 12 in. adjustable length is also available.

-Twist-Lock System (Ø int. 5 to 10 inches)

| Number of overlaps | | | | | | | |
|--------------------|--------|--------|--------|---------|--------|----------|-------|
| 1 | 2 | 3 | 4 | 5 | 6 | 7 | 8 |
| 1-3/16 | 2-3/8 | 3-9/16 | 4-3/4 | 5-15/16 | 7-1/8 | 8-5/16 | 9-1/2 |
| 9 | 10 | 11 | 12 | 13 | 14 | 15 | |
| 10-11/16 | 11-7/8 | 13-1/8 | 14-1/4 | 15-7/16 | 16-5/8 | 17-13/16 | |

SecureTemp™ ASHT+

| | | One length between elbows (in.) | | | | | | |
|-------|----------|----------------------------------|----------|----------|----------|----------|----------|----------|
| Angle | Size | 8 | 12 | 18 | 24 | 36 | 48 | |
| 15 | 5@10 in. | Offset (in.) | 3 3/16 | 4 3/16 | 5 7/8 | 7 7/16 | 10 1/2 | 13 3/8 |
| | | Rise (in.) | 15 11/16 | 19 3/16 | 25 3/8 | 31 3/16 | 42 3/4 | 54 3/8 |
| | | Two lengths between elbows (in.) | | | | | | |
| | | 8 & 48 | 12 & 48 | 18 & 48 | 24 & 48 | 36 & 48 | 48 & 48 | |
| | | Offset (in.) | 15 3/8 | 16 7/16 | 18 | 19 1/2 | 22 3/8 | 25 3/4 |
| | | Rise (in.) | 60 15/16 | 64 13/16 | 70 7/16 | 76 3/8 | 87 | 99 7/16 |
| | | One length between elbows (in.) | | | | | | |
| Angle | Size | 8 | 12 | 18 | 24 | 36 | 48 | |
| 30 | 5@10 in. | Offset (in.) | 7 7/16 | 9 7/16 | 12 7/16 | 15 7/16 | 21 1/16 | 27 7/16 |
| | | Rise (in.) | 20 | 23 1/2 | 28 11/16 | 33 3/8 | 44 1/4 | 54 11/16 |
| | | Two lengths between elbows (in.) | | | | | | |
| | | 8 & 48 | 12 & 48 | 18 & 48 | 24 & 48 | 36 & 48 | 48 & 48 | |
| | | Offset (in.) | 30 13/16 | 32 13/16 | 35 13/16 | 38 13/16 | 44 3/16 | 50 13/16 |
| | | Rise (in.) | 60 7/16 | 64 | 69 1/4 | 74 7/16 | 84 13/16 | 95 1/4 |

Offset and Rise Calculation.

The following steps will help determine the lengths required for an installation:

Determine the offset required in view of the obstacles that must be avoided. Refer to the chart to determine the elbows required as well as the insulated lengths needed.

Check the corresponding offset height dimensions.

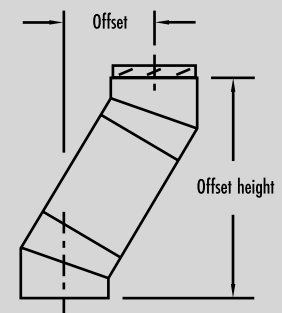

Security Chimneys International's Secure Temp™ASHT+ high-temperature factory-built chimney has been designed for ease of installation and maximum safety in many applications, featuring our fast and easy Twist-Lock assembly system. No other part is required to ensure the stability of the installation. See how simple the typical installations are in the following diagrams.

Exterior installation of a Secure Temp™ASHT+ high-temperature chimney on a stove in an accessible chase.

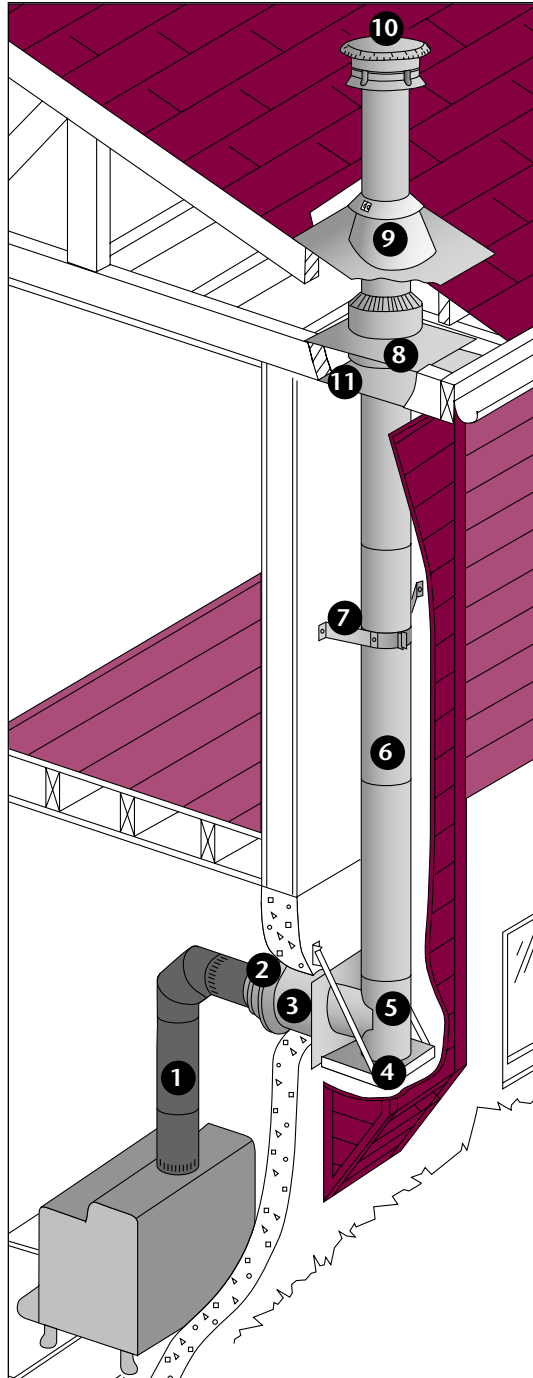

1. Black stove pipe
2. Finishing cone
3. Insulated wall radiation shield
4. Wall support
5. Insulated tee
6. Insulated length
7. Universal wall band
8. Insulated attic radiation shield
9. Adjustable vented roof flashing
10. Rain cap
11. Firestop

Interior installation of a Secure Temp™ASHT+ high-temperature chimney on a stove using a finishing support.

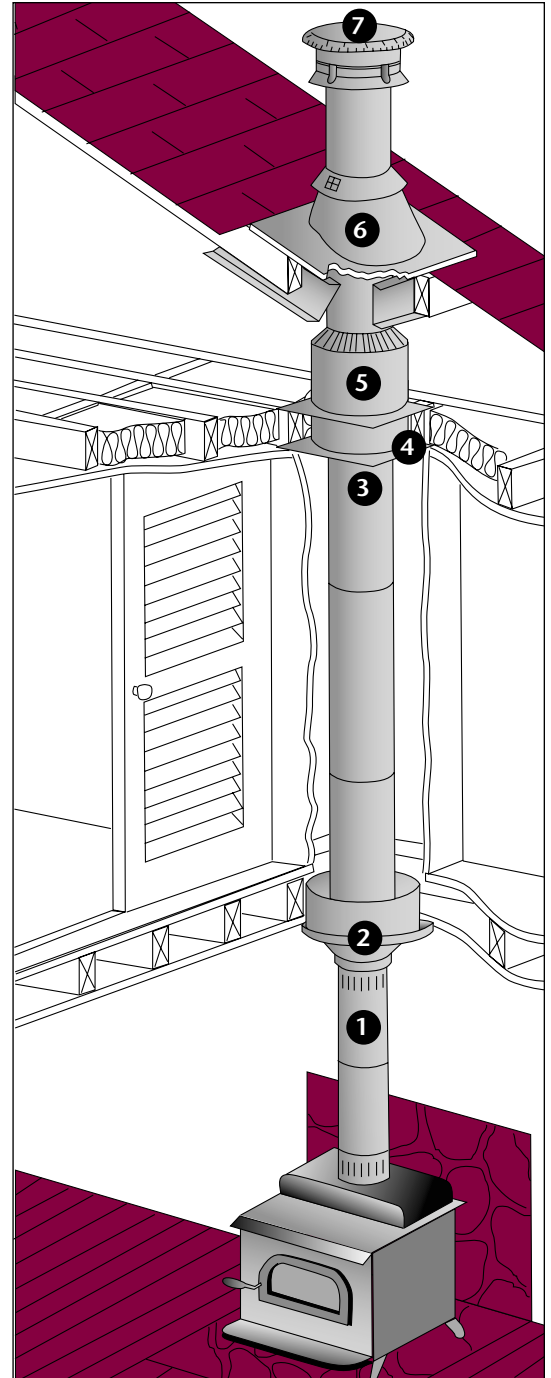

1. Black stove pipe
2. Finishing support
3. Insulated length
4. Firestop
5. Insulated attic radiation shield
6. Adjustable vented roof flashing
7. Rain cap

Interior installation of a Secure Temp™ ASHT+ high-temperature chimney to a furnace.

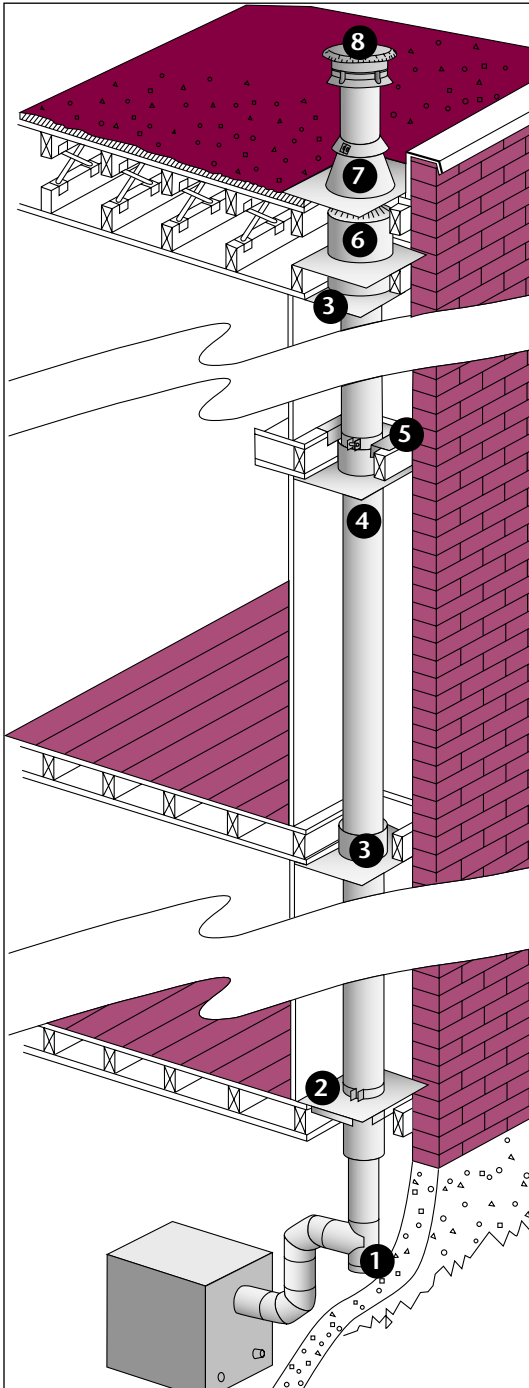

1. Base tee
2. Floor support
3. Firestop
4. Insulated length
5. Universal roof support
6. Insulated attic radiation shield
7. Flat roof vented flashing
8. Rain cap

Interior installation of a Secure Temp™ ASHT+ high-temperature chimney on a stove in a mobile home.

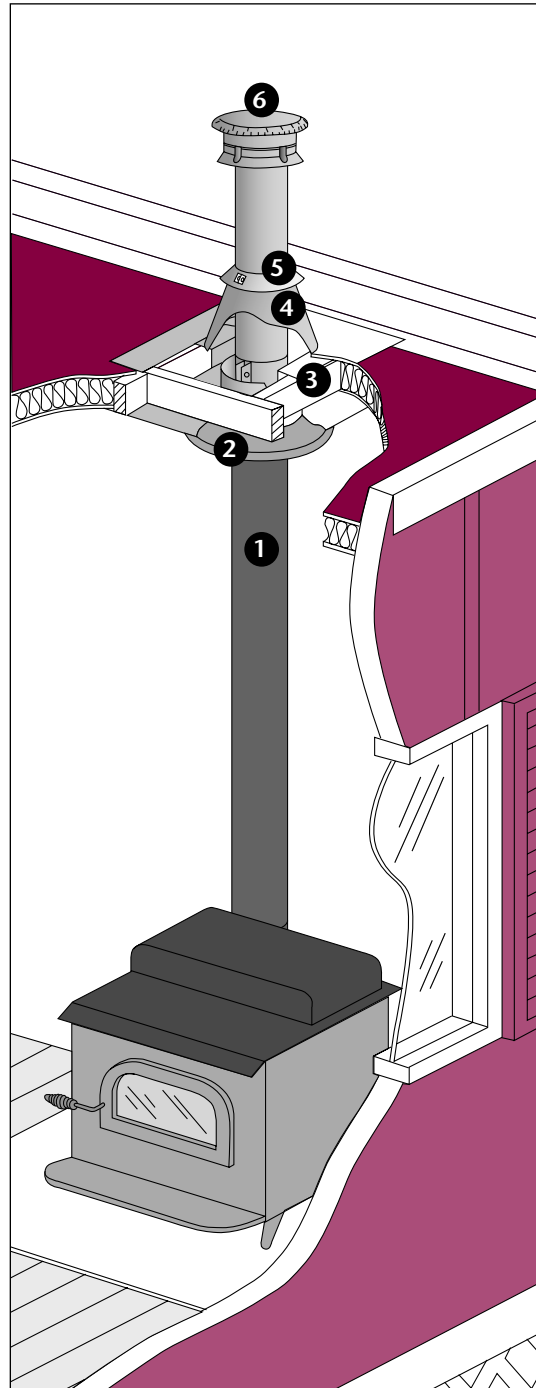

1. Black stove pipe
2. Finishing support
3. Universal roof support
4. Vented flat roof flashing
5. Storm collar
6. Rain cap

Coding logic This document contains a description of each of the parts for the **Secure Temp™ ASHT+** system, as well as their respective application. Each part has a reference letter that identifies the product.
The following examples of our coding system should make it easier for you to identify or order them:

Insulated Lengths

5 diameters and 6 standard effective lengths featuring a 1/8 turn Twist-Lock assembly.

Various lengths may be combined to obtain the required installation height.

Also available in 6", 7" and 8" I.D. aluminum-zinc coated steel outer casing.

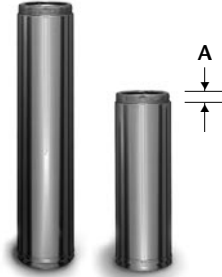

Adjustable Length 12"

Used in combination with straight insulated lengths, the adjustable length makes it possible to fit a **SecureTemp™ ASHT+** length perfectly.

IMPORTANT: The adjustable length is not designed as a loadbearing component. Its vertical installation requires an appropriate support on the section above it to bear the weight of the remaining installation.

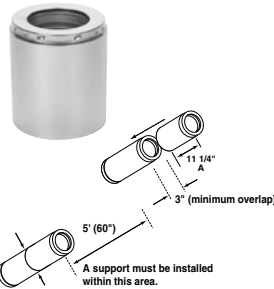

Insulated Tee

Located at the base of the chimney, it allows the horizontal connection of the chimney to the appliance. It is recommended for installations where a connector must pass through an exterior wall. Installed inside, it provides access for inspection and cleaning. An insulated tee cap (TCS) included, must be used with wall support.

Also available in 6", 7" and 8" I.D. aluminum-zinc coated steel outer casing.

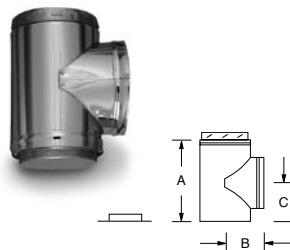

Insulated Tee Cap

Equipped with a Twist-Lock system, it makes it possible to seal the base of an insulated tee. Its insulation also prevents the cooling of chimney gases, especially in exterior installations. Must be combined with an adjustable wall support only. Removable, it provides easy access for chimney maintenance or inspection. Must be combined with an adjustable wall support only.



Drain Tee Cap

Fitted at the base of an insulated tee, it makes it possible to collect and drain rain water and condensates. The drain tee cap connects to a drain (NPT 0 1"). Removable, it provides easy access for chimney maintenance or inspection. Must be combined with an adjustable wall support only.



Base Tee

Located at the base of the chimney, it makes it possible to connect the chimney to the appliance. It is recommended for interior installations only and must be attached to a flue extension to ensure an 18" clearance when installed with a regular black stove pipe connector. The galvanized steel base tee comes complete with a tee cap providing access for inspection and cleaning.

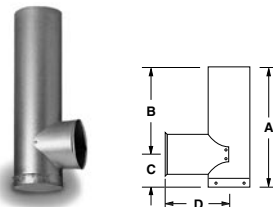

| 6L36 | | 6FAR | |
|-------------|----|----------------------------|---|
| Size | 6 | Interior diameter | 6 |
| Reference | L | Insulated length | F |
| Specificity | 36 | Insulated 36" length | A |
| | | | R |
| | G | Aluminum-zinc coated steel | |

Ref. L
Ref. GL 6"-7"-8"

| | Secure Temp™ ASHT+ | | | High-Temperature | |
|---------|--------------------|--------|--------|------------------|--------|
| Ø int. | 5 | 6 | 7 | 8 | 10 |
| Ø ext. | 7 | 8 | 9 | 10 | 12 |
| 8 | | • | • | • | • |
| 12 | • | • | • | • | • |
| 18 | | • | • | • | • |
| 24 | • | • | • | • | • |
| 36 | • | • | • | • | • |
| 48 | • | • | • | • | • |
| Lb./ft. | 4.1 | 5.2 | 6.4 | 7.2 | 8.9 |
| A | 1 3/16 | 1 3/16 | 1 3/16 | 1 3/16 | 1 3/16 |

Ref. LA
Ref. GLA 6"-7"-8"

| | | | | | |
|--------|---|---|---|---|----|
| Ø ext. | 5 | 6 | 7 | 8 | 10 |
| A | • | • | • | • | • |

Ref. TI
Ref. GLI 6"-7"-8"

| | Secure Temp™ ASHT+ | | | High-Temperature | |
|--------|--------------------|--------|--------|------------------|-------|
| Ø int. | 5 | 6 | 7 | 8 | 10 |
| Ø ext. | 7 | 8 | 9 | 10 | 12 |
| A | 9 1/2 | 10 3/4 | 11 3/4 | 13 | 15 |
| B | 4 3/4 | 5 1/4 | 5 1/4 | 6 1/4 | 7 1/4 |
| C | 5 1/2 | 6 | 6 1/2 | 7 1/4 | 8 1/4 |

Ref. TCI

| | Secure Temp™ ASHT+ | | | High-Temperature | |
|--------|--------------------|---|---|------------------|----|
| Ø int. | 5 | 6 | 7 | 8 | 10 |

Ref. TCP

| | Secure Temp™ ASHT+ | | High-Temperature | |
|--------|--------------------|---|------------------|----|
| Ø int. | 6 | 7 | 8 | 10 |

Ref. TCP

| | Secure Temp™ ASHT+ | | High-Temperature | |
|--------|--------------------|--------|------------------|-------|
| Ø int. | 6 | 7 | 8 | 10 |
| A | 23 | 24 | 25 | 27 |
| B | 18 | 18 1/2 | 19 | 20 |
| C | 5 | 5 1/2 | 6 | 7 |
| D | 5 1/2 | 6 | 6 1/2 | 7 1/2 |

Ref. TBD

| Ø int. | Secure Temp™ ASHT+ | | High-Temperature | | |
|--------|--------------------|--------|------------------|-------|--|
| | 6 | 7 | 8 | 10 | |
| A | 31 | 33 | 35 | 39 | |
| B | 18 | 18 1/2 | 19 | 20 | |
| C | 5 | 5 1/2 | 6 | 7 | |
| D | 5 1/2 | 6 | 6 1/2 | 7 1/2 | |
| E | 8 | 9 | 10 | 12 | |

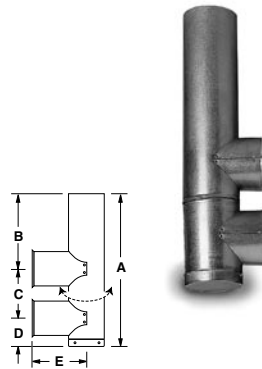

Base Tee for Twin Connections

This component makes it possible to connect two appliances, such as a furnace and a water heater to the SecureTemp™ ASHT+ chimney (TBD, Type A application, UL-103 only). The galvanized steel base tee for twin connections comes complete with a tee cap providing access for inspection and cleaning.

**Ref. E15
Ref. GE15 6"-7"-8"**

| Ø int. | Secure Temp™ ASHT+ | | High-Temperature | | |
|--------|--------------------|-------|------------------|-------|-------|
| | 5 | 6 | 7 | 8 | 10 |
| Ø ext. | 7 | 8 | 9 | 10 | 12 |
| A | 1/2 | 1/2 | 1/2 | 1/2 | 1/2 |
| B | 4 1/2 | 4 1/2 | 4 1/2 | 4 1/2 | 4 1/2 |

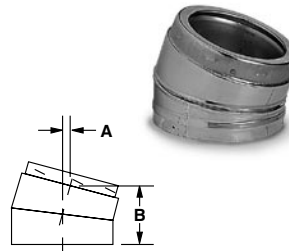

15° Insulated Elbow

Allows the 15° offset of a chimney. Designed to by-pass an obstacle, such as a joist. A maximum of two offsets (4 elbows) is allowed. The minimum recommended height for an installation with a 15° offset is 10'.

Also available: 6", 7" and 8" I.D. aluminum-zinc coated steel casing.

**Ref. E30
Ref. GE30 6"-7"-8"**

| Ø int. | Secure Temp™ ASHT+ | | High-Temperature | | |
|--------|--------------------|-------|------------------|-------|-------|
| | 5 | 6 | 7 | 8 | 10 |
| Ø ext. | 7 | 8 | 9 | 10 | 12 |
| A | 2 | 2 | 2 | 2 | 2 |
| B | 7 1/2 | 7 1/2 | 7 1/2 | 7 1/2 | 7 1/2 |

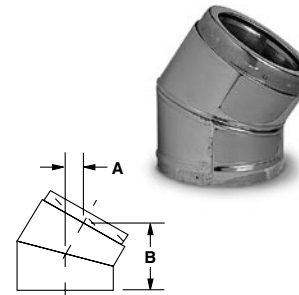

30° Insulated Elbow

Allows the 30° offset of a chimney. Designed to by-pass an obstacle, such as a joist. A maximum of two offsets (4 elbows) is allowed. The chimney's angle of inclination must not deviate more than 30° from the vertical position. The minimum recommended height for an installation with a 30° offset is 15'.

Also available: 6", 7" and 8" I.D. aluminum-zinc coated steel casing.

Ref. S2

| Ø int. | 5 | 6 | 7 | 8 |
|--------|--------|--------|--------|--------|
| A | 14 3/8 | 14 3/8 | 14 3/8 | 14 3/8 |
| B | 5 | 6 1/4 | 7 1/2 | 8 1/4 |
| C | 20 | 20 | 20 | 20 |
| D | 5 1/2 | 5 1/2 | 5 1/2 | 5 1/2 |
| E | 3 | 3 | 3 | 3 |

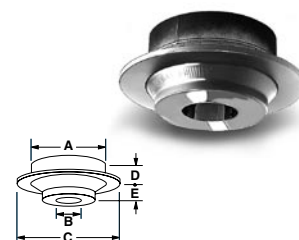

Base Support

This part supports the chimney from a floor or ceiling joist. It includes a radiation shield that makes it possible to maintain a 2" clearance between the chimney's outer casing and combustible materials in its path. The base support is attached to a frame from the joists. (Refer to charts for loadbearing capacity and frame sizes.)

Ref. SD

| Ø int. | 5 | 6 | 7 | 8 | 10 |
|--------|----|----|----|----|----|
| A | 7 | 8 | 9 | 10 | 12 |
| B | 11 | 12 | 13 | 14 | 16 |
| C | 16 | 16 | 16 | 18 | 18 |

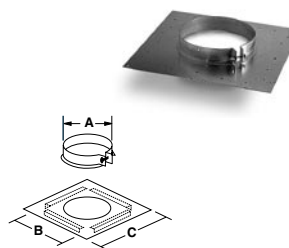

Floor Support

This part supports the chimney on a slab, floor or joist. It makes it possible to maintain a 2" clearance between the chimney's outer casing and combustible materials in its path. A tightening collar locked around the chimney and secured by self-taping screws (supplied) rests on a horizontal plate screwed or nailed to the floor or slab, which can serve as an intermediate support. (Refer to chart for loadbearing capacity.)

Finishing Support with Coupler

This part supports the chimney from a ceiling. Designed to connect the stove pipe to the flue extension (supplied), it is enhanced by a decorative black finish. It must be attached to a frame built from the joists. (Refer to charts for size of openings and loadbearing capacity.)

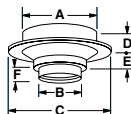

| Ref. SFC | | | | |
|----------|--------|---------|--------|--------|
| Ø int. | 5 | 6 | 7 | 8 |
| A | 14 3/8 | 14 3/8 | 14 3/8 | 14 3/8 |
| B | 5 1/4 | 6 15/64 | 7 1/4 | 8 1/4 |
| C | 20 | 20 | 20 | 20 |
| D | 5 1/2 | 5 1/2 | 5 1/2 | 5 1/2 |
| E | 3 | 3 | 3 | 3 |
| F | 2 | 2 | 2 | 2 |

Round Cathedral Support with Coupler

This part supports the chimney from a cathedral ceiling. Designed to connect the stove pipe to the flue extension (supplied), it is enhanced by a decorative black finish. It comes with a decorative trim collar and must be attached to a frame built from the joists. (Refer to charts for size of openings and loadbearing capacity.)

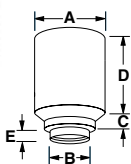

| Ref. SCC | | | |
|----------|--------|--------|--------|
| Ø int. | 6 | 7 | 8 |
| A | 14 3/8 | 14 3/8 | 14 3/8 |
| B | 6 1/4 | 7 1/4 | 8 1/4 |
| C | 3 | 3 | 3 |
| D | 13 | 13 | 13 |

Square Cathedral Support with Coupler

This part has the same features as the cathedral support with black finish. It comes with a flue extension. (Refer to charts for size of openings and loadbearing capacity.)

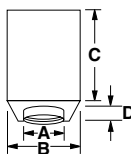

| Ref. SSC | | | |
|----------|--------|--------|--------|
| Ø int. | 6 | 7 | 8 |
| A | 6 1/4 | 7 1/4 | 8 1/4 |
| B | 14 3/8 | 14 3/8 | 14 3/8 |
| C | 17 | 17 | 17 |
| D | 2 | 2 | 2 |

Adjustable Square Support, Black w/Framing Arms and Coupler

This 12" support can be installed between 16" on center with 2 1/2" free play to eliminate the need for elbows. No framing is required.

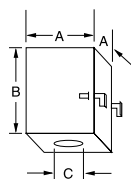

| Ref. SSAC | | |
|-----------|----|----|
| Ø int. | 5 | 6 |
| A | 12 | 12 |
| B | 17 | 17 |
| C | 5 | 6 |

Square Support Extension

This part is designed to extend the finish of the cathedral support when the pitch of the roof is quite steep. It must be attached to the square cathedral support. It fits all diameters of the square cathedral support (SS).

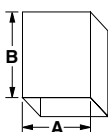

| Ref. PS | |
|---------|--------|
| A | 14 3/8 |
| B | 17 |

Ref. ST

| Ø int. | 5 | 6 | 7 | 8 | 10 |
|--------|---|---|---|---|----|
| A | 8 | 8 | 8 | 8 | 8 |
| B | 4 | 4 | 4 | 4 | 4 |
| C | 2 | 2 | 2 | 2 | 2 |

Ref. SM

| Ø int. | 6 | 7 | 8 | 10 |
|--------|----|----|----|----|
| A | 19 | 19 | 19 | 16 |
| B | 13 | 13 | 13 | 16 |
| C | 16 | 16 | 16 | 16 |

Ref. SME

| Ø int. | 5 | 6 | 7 | 8 | 10 |
|--------|--------------------------------|--------------------------------|--------------------------------|--------------------------------|--------------------------------|
| A | 13 | 13 | 13 | 13 | 16 |
| B | 16 | 16 | 16 | 16 | 16 |
| C | 26 ³ / ₄ | 26 ³ / ₄ | 26 ³ / ₄ | 26 ³ / ₄ | 26 ³ / ₄ |
| D | 0 to 5 | 0 to 5 | 0 to 5 | 0 to 5 | 0 to 5 |

Ref. SO

| Ø int. | 5 | 6 | 7 | 8 | 10 |
|--------|-------|-------|--------|--------|--------|
| A | 8 1/2 | 9 1/2 | 10 1/2 | 11 1/2 | 13 1/2 |
| B | 12 | 12 | 12 | 12 | 12 |
| C | 2 3/4 | 2 3/4 | 2 3/4 | 2 3/4 | 2 3/4 |
| D | 2 | 2 | 2 | 2 | 2 |

Ref. SP

| Ø int. | 5 | 6 | 7 | 8 | 10 |
|--------|----|----|----|----|----|
| A | 5 | 6 | 7 | 8 | 10 |
| B | 12 | 12 | 12 | 12 | 14 |
| C | 2 | 2 | 2 | 2 | 2 |
| D | 3 | 3 | 3 | 3 | 3 |

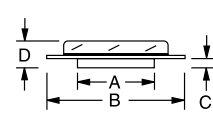
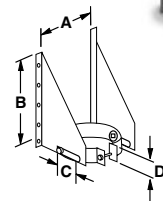
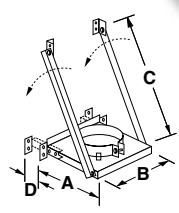
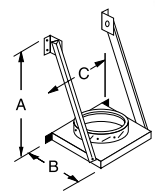
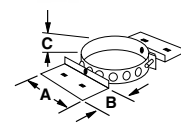

Universal Roof Support

This complementary support is usually attached to a roof structure.

It is designed to support the chimney:

- from the roof, adjusting to any roof pitch
- above an offset
- when the chimney height exceeds the loadbearing capacity of the primary support.

Two adjustable attachments screwed to the structure adapt to the pitch of the roof. A tightening collar is attached and locks around the chimney and is secured by self-taping screws (supplied). (Refer to the chart for loadbearing capacity.)

Wall Support

This part supports the chimney at the base of the installation. It is designed with a male coupler to accommodate the first section of the chimney. This support is made of galvanized steel and must be installed with the insulated tee cap included with the tee.

Adjustable Wall Support

This part supports the chimney at the base of the installation, or along a wall or other vertical surface serving as an intermediate support. It comes with a tightening collar locked around the chimney and secured by two self-taping screws (supplied). The collar rests on a horizontal plate. When used as a base support, it lends itself to the addition of an insulated tee cap or drain tee cap. Available in galvanized steel. (See chart for loadbearing capacity.)

Universal Offset / Wall Support

This part is designed to support the chimney above the offset on a vertical wall. The triangular plates allow a 2" to 4" lateral adjustment of the support to the vertical surface. (Refer to chart for load-bearing capacity.)

This support can also be used as a wall support above the insulated tee. When used as a wall support, it lends itself to the addition of an insulated tee cap or drain tee cap.

Anchor Plate

This part is attached to a masonry or metal-casing fireplace to provide a proper connection to the SecureTemp™ ASHT+ chimney.

Flue Extension

Fitted to the base of the first chimney length, this component makes it possible to extend the inner casing, thereby facilitating the attachment of the stove pipe or other type of connector. It can also be attached directly to the appliance outlet. The crimped end of this component is slightly tapered for easier assembly.



| Ref. UP | | | | | |
|---------|---|---|---|---|----|
| Ø int. | 5 | 6 | 7 | 8 | 10 |
| A | 3 | 3 | 3 | 3 | 3 |
| B | 5 | 6 | 7 | 8 | 10 |

Radiation Shield

Protects combustible materials when the chimney passes through a floor or a ceiling. It ensures a 2" safety clearance between the chimney's outer casing and surrounding combustibles.

When passing through a ceiling to an attic, it must be installed from the underside of the ceiling along with an attic radiation shield (RSA2) for HT Type applications with a stove.

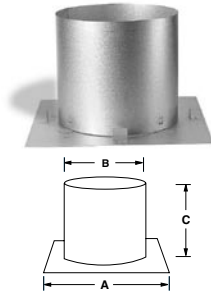

| Ref. RS | | | | | |
|---------|---|----|----|----|----|
| Ø int. | 5 | 6 | 7 | 8 | 10 |
| A | | 16 | 16 | 16 | 16 |
| B | | 11 | 12 | 13 | 15 |
| C | | 10 | 10 | 10 | 10 |

Insulated Radiation Shield

Available in diameters of 7", 8" and 10" only, it must be used with a wood-burning stove (certified for use with the Secure Temp™ ASHT+). It should be used where the chimney passes through a ceiling or exterior opening when insulation is required. It must be used in combination with an attic radiation shield when passing through an attic.

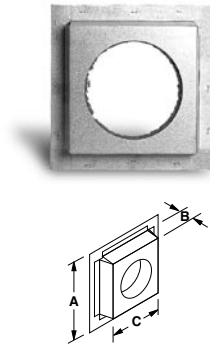

| Ref. RSI | | | | |
|----------|----|----|----|--|
| Ø int. | 7 | 8 | 10 | |
| A | 16 | 16 | 18 | |
| B | 3 | 3 | 3 | |
| C | 13 | 13 | 15 | |

Two-Piece Insulated Attic Radiation Shield

It protects combustible materials when a chimney passes through an attic. It is imperative that it be installed overside, from the attic, and combined with the radiation shield in HT applications. Its cone shape keeps insulation from seeping between the outer casing and the firestop. It also maintains a 2" safety clearance from combustible materials.

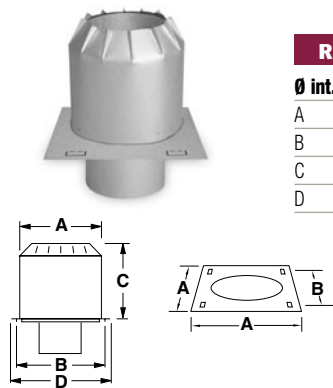

| Ref. RSA2 | | | | | |
|-----------|----|----|----|----|----|
| Ø int. | 5 | 6 | 7 | 8 | 10 |
| A | 11 | 12 | 13 | 14 | 16 |
| B | 11 | 12 | 13 | 14 | 16 |
| C | 12 | 12 | 12 | 12 | 12 |
| D | 16 | 16 | 16 | 16 | 18 |

Adjustable Insulated Attic Radiation Shield

This has the same features as the two-piece insulated attic radiation shield but its height is adjustable from 12 to 22 inches.

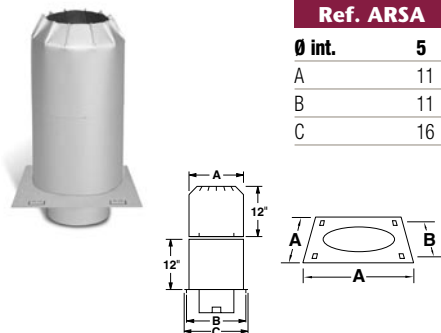

| Ref. ARSA | | | | | |
|-----------|----|----|----|----|----|
| Ø int. | 5 | 6 | 7 | 8 | 10 |
| A | 11 | 12 | 13 | 14 | 16 |
| B | 11 | 12 | 13 | 14 | 16 |
| C | 16 | 16 | 16 | 16 | 18 |

| Ref. UP | | | | | |
|---------|-----------------|-------|-------|--------|----|
| Ø int. | 5 | 6 | 7 | 8 | 10 |
| A | 20 | 20 | 20 | 20 | |
| B | 7 1/4 | 8 1/4 | 9 1/4 | 10 1/4 | |
| C | ← 7 to 12 1/2 → | | | | |
| D | 14 | 16 | 16 | 16 | 18 |
| E | 11 | 12 | 13 | 14 | 16 |

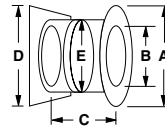

Insulated Wall Radiation Shield

Designed to protect surrounding combustible materials when a chimney crosses through a wall horizontally, this shield can be adjusted from 7" to 12 1/2" to adapt to the thickness of the wall opening. A decorative plate painted in black provides an interior finish. This component is available in diameters of 5", 6", 7", 8" and 10".

| Ref. RSMI30 | | | | |
|-------------|--------|--------|--------|----------|
| Ø int. | 6 | 7 | 8 | 10 |
| A | 34 3/4 | 37 1/4 | 39 1/4 | 42 13/16 |
| B | 15 1/8 | 16 1/8 | 17 1/8 | 18 1/8 |
| C | 17 1/8 | 18 1/8 | 19 1/8 | 20 1/8 |
| D | 36 3/4 | 39 1/4 | 41 1/4 | 44 13/16 |
| E | 3 | 3 | 3 | 3 |

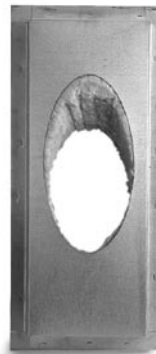
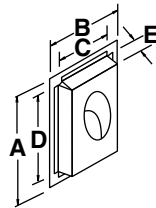

Insulated Wall Radiation Shield 30°

This part is to be used only with wood-burning fireplaces manufactured by Security Chimneys International, and wood-burning fireplaces that have been certified with these components. It has been designed for use when the chimney passes through a wall at an angle.

| Ref. RSM30 | | | | |
|------------|---------|---------|---------|---------|
| Ø int. | 6 | 7 | 8 | 10 |
| A | 15 5/8 | 16 5/8 | 17 5/8 | 19 3/8 |
| B | 35 1/4 | 37 3/4 | 39 3/4 | 43 5/16 |
| C | 13 5/16 | 14 9/16 | 15 9/16 | 17 3/8 |

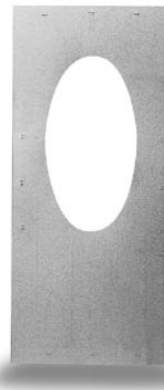
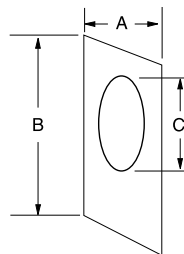

Angled Firestop 30°

These angled firestops are to be used only with wood-burning fireplaces in the Security Fireplace line and others that have been certified for use with the chimney.

| Ref. BF | | | | | |
|---------|----|----|----|----|----|
| Ø int. | 5 | 6 | 7 | 8 | 10 |
| A | 14 | 16 | 16 | 16 | 18 |
| B | 11 | 12 | 13 | 14 | 16 |

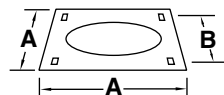

Firestop

Designed to be used in combination with a radiation shield, it provides additional protection when the chimney passes through combustible materials. Must be installed below each combustible floor the chimney goes through.

Flat Roof Flashing*

This component seals a chimney length when passing through a flat roof and comes complete with a storm collar. For HT applications, 4 radiation shields (supplied) must be installed on the roof joists.

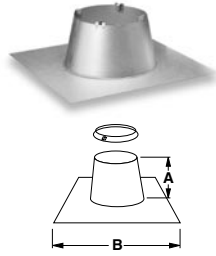

| Ref. FR | | | | | |
|---------|-------|-------|-------|-------|-------|
| Ø int. | 5 | 6 | 7 | 8 | 10 |
| A | 7 1/2 | 7 1/2 | 7 1/2 | 7 1/2 | 7 1/2 |
| B | 20 | 24 | 24 | 24 | 24 |

Peak Roof Flashing*

This component is required for chimney installations passing through the roof peak. For HT applications, 4 radiation shields (supplied) must be installed on the roof joists.

It is available in two models:

- Peak roof: 1/12 to 7/12 FPR
- Peak roof: 8/12 to 12/12 FPBR

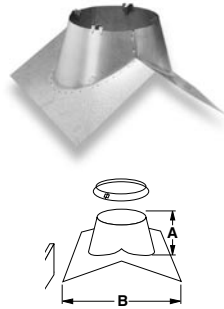

| Ref. FPR/FPBR | | | | |
|------------------|-------|-------|--------|-------|
| Ø int. | 6 | 7 | 8 | 10 |
| Ref. FPR | | | | |
| A | 3 5/8 | 3 5/8 | 3 5/8 | 3 5/8 |
| B | 12 | 13 | 13 1/2 | 15 |
| Ref. FPBR | | | | |
| A | 5 | 4 | 3 1/4 | 1 1/2 |
| B | 14 | 14 | 14 | 14 |

* All flashings are vented.

Adjustable Roof Flashing*

This part is required to accommodate sloped roof installations.

For HT applications, 4 radiation shield roof plates (supplied) must be installed on the roof joists.

Available in five versions to adapt to the needs of the following roof slopes:

- 1/12 to 7/12 pitch: FAR
- 8/12 to 12/12 pitch: FBR
- 12/12 to 21/12 pitch: FBBR

Also available: aluminum base plate in 6", 7" and 8" I.D. (Ref. FARA and FBRA)

These malleable base plates are easier to install on metal or uneven roofs.

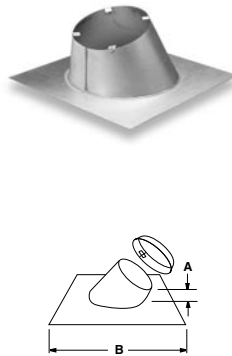

| Ref. FAR/FBR/FBBR | | | | | |
|-------------------|----|-------|-------|-------|-------|
| Ø int. | 5 | 6 | 7 | 8 | 10 |
| Ref. FAR | | | | | |
| A | 6 | 6 | 6 | 6 | 6 |
| B | 24 | 24 | 24 | 24 | 24 |
| Ref. FBR | | | | | |
| A | | 6 | 4 3/8 | 3 7/8 | 3 7/8 |
| B | | 24 | 24 | 24 | 30 |
| Ref. FBBR | | | | | |
| A | | 6 1/4 | 6 1/4 | 6 1/4 | 6 1/4 |
| B | | 36 | 36 | 36 | 42 |

| Ref. FARA/FBRA | | | |
|------------------|----|----|----|
| Ø int. | 6 | 7 | 8 |
| Ref. FARA | | | |
| B | 36 | 36 | 36 |
| Ref. FBRA | | | |
| B | 36 | 36 | 36 |

Storm Collar

Designed to fit over flashings, it provides a weathertight seal. It is automatically supplied with roof flashings.



| Ref. FC | | | | | |
|---------|---|---|---|---|----|
| Ø int. | 5 | 6 | 7 | 8 | 10 |
| A | 5 | 5 | 5 | 5 | 5 |

* All flashings are vented.

Ref. BME

| Ø int. | 6 | 7 | 8 | 10 |
|--------|--------------------------------|--------------------------------|-------------------------------|--------------------------------|
| A | 7 | 8 | 8 ⁵ / ₈ | 10 |
| B | 5 ³ / ₁₆ | 6 ¹ / ₁₆ | 6 ³ / ₄ | 8 ³ / ₁₆ |
| C | 2 | 2 | 2 | 2 |

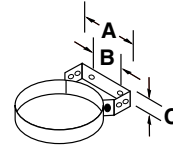

Reinforced Wall Band

Intended primarily to stabilize a chimney along an exterior wall in areas subject to high winds, it ensures a 2" clearance between the outer casing of the chimney and the wall. The use of these bands at 10' intervals is recommended. These bands are available in galvanized steel.

Ref. BEE

| Ø int. | 6 | 7 | 8 | 10 |
|--------|--------------------------------|--------------------------------|-------------------------------|--------------------------------|
| A | 4 1/2 | 4 1/2 | 4 1/2 | 4 1/2 |
| B | 5 ³ / ₁₆ | 6 ¹ / ₁₆ | 6 ³ / ₄ | 8 ³ / ₁₆ |
| C | 2 | 2 | 2 | 2 |
| D | 5 1/2 | 5 1/2 | 5 1/2 | 5 1/2 |

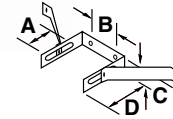

Wall Band Extension

When used in combination with a wall band, it extends the clearance between the chimney's outer casing and the wall from 2" to 4". It comes in galvanized steel.

Ref. BM

| Ø int. | 5 | 6 | 7 | 8 |
|--------|----|----|----|----|
| A | 7 | 8 | 9 | 10 |
| B | 19 | 21 | 23 | 25 |
| C | 2 | 2 | 2 | 2 |

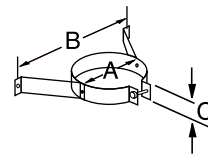

Universal Wall Band

Designed for use on an interior or exterior wall, it serves to stabilize the chimney while providing the required clearance from the combustible surface. The use of wall bands at maximum intervals of 8' is recommended.

Ref. BS2

| Ø int. | 5 | 6 | 7 | 8 |
|--------|---------------|---|---|----|
| A | 7 | 8 | 9 | 10 |
| B | ← 60 to 115 → | | | |

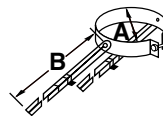

Universal Roof Brace

Designed to stabilize a chimney extending from 5' to 9' beyond the roof, or when a chimney is exposed to high winds, this part is supplied with tightening collar and adjustable legs.

Ref. BH

| Ø int. | 6 | 7 | 8 | 10 |
|--------|---|---|---|----|
| A | 2 | 2 | 2 | 2 |

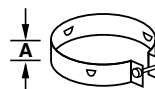

Guy Wire Band

Attached to the outer casing of the chimney (secured by bolts), it is designed to hold 3 guy wires (guy wires not included). It is recommended for chimneys exceeding the roof by 5' to 13' maximum.

Rain Cap

Attached to the top of the chimney, it effectively prevents rain, snow or leaves from entering the opening.

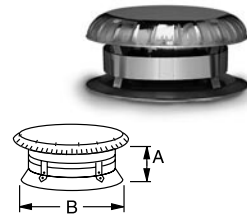

| Ref. CC | | | | | |
|---------|--------|--------|--------|--------|--------|
| Ø int. | 5 | 6 | 7 | 8 | 10 |
| A | 4 3/4 | 4 3/4 | 4 3/4 | 4 3/4 | 4 3/4 |
| B | 15 1/2 | 15 1/2 | 15 1/2 | 15 1/2 | 15 1/2 |

Spark Arrester Band

This spark arrester band is wrapped around the rain cap, preventing sparks from falling onto the roof.

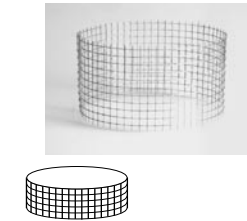

| Ref. PE | | | | | |
|------------------------------------|--|--|--|--|--|
| Universal piece fits all diameters | | | | | |

Decorative Trim

The use of this decorative trim provides a flawless finish when a chimney must pass through a ceiling or any wall.

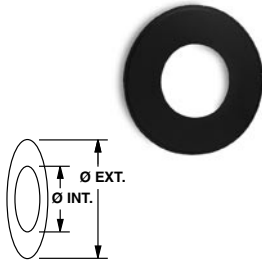

| Ref. PF | | | | | |
|---------|----|----|----|----|----|
| Ø int. | 6 | 7 | 8 | 10 | |
| Ø ext. | 20 | 20 | 20 | 20 | 20 |

Decorative Collar

This component provides a finish between the Secure Temp™ ASHT+ chimney's female coupler and the appliance connector.

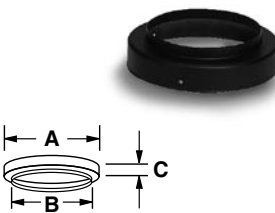

| Ref. PB | | | | | |
|---------|----|----|----|--------|--|
| Ø int. | 6 | 7 | 8 | 12 | |
| A | 10 | 11 | 12 | 12 1/4 | |
| B | 6 | 7 | 8 | 10 | |
| C | 1 | 1 | 1 | 1 | |

Black Pipe Adaptor

This component is recommended for connecting a standard black pipe to the Secure Temp™ ASHT+ chimney when a longer extension length is required. A finishing collar is supplied.



| Ref. PA | | | | | |
|---------|----|----|----|----|--|
| Ø int. | 6 | 7 | 8 | 10 | |
| A | 12 | 12 | 12 | 12 | |

Finishing Cone

When the chimney passes through an exterior wall, a finishing cone may be necessary. It is designed to conceal the protrusion of the insulated length (5") inside, and makes it possible to respect the 6" clearance permitted by Security Chimneys International's double-wall black connector. A flue extension must be used to ensure a perfect connection between the chimney and the double-wall black connector.

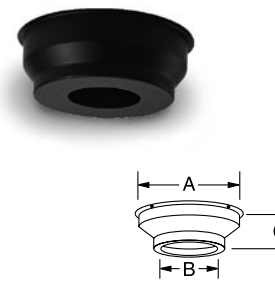

| Ref. PD | | | | | |
|---------|--------|--------|--------|--|--|
| Ø int. | 6 | 7 | 8 | | |
| A | 14 3/8 | 14 3/8 | 14 3/8 | | |
| B | 6 1/4 | 7 1/4 | 8 1/4 | | |
| C | 5 1/2 | 5 1/2 | 5 1/2 | | |



Over the past 50 years, Security Chimneys International's dedication to engineering excellence has led to the development of a wide range of quality venting products, as well as wood-burning fireplaces.



Security Chimneys International Ltd.
2125 Monterey
Laval (Quebec)
Canada H7L 3T6
Tel.: (450) 973-9999
Fax.: (450) 973-2222
www.SecurityChimneys.com



© Lennox Industries, Inc. 2008
USCASHT-1
REV: 8 10-2008

CI

- For residential, commercial and industrial applications on boilers using gas or liquid fuel with negative or positive pressure, and on high-pressure appliances with condensation.
- Available in various gauges of stainless steel, depending on specifications and intended use.
- Certified to ULC-S604, UL-103 "Residential" (12 to 18 in.) UL-103 "Industrial" (5 to 24 in.) and UL103HT (12 to 24 in.).
- Available in diameters of 5 to 24 inches.

B-VENT

- Compatible with all gas applications.
- Certified to ULC-S605 and UL-441 standards.
- Available in diameters of 8 to 36 inches.

CT

- For use in vertical tubing for masonry chimneys.
- For independent use on high-efficiency gas boilers with condensation, in vertical and/or horizontal, interior or exterior installations.
- Certified to ULC and UL standards.
- Available in diameters of 5 to 24 inches.

TUBINOX

- To reline an existing masonry chimney, or to substitute the clay liner in a new masonry chimney.
- Certified to ULC-S635M, UL-1777 and ULC-S640M standards.
- Available in diameters of 5 and 8 inches.

SP/SPC VENT (FOR PELLET OR CORN STOVES)

- Aluminum-zinc coated steel outer casing for better corrosion resistance.
- Attractive black painted outer casing also available.
- Durable stainless steel flue.
- New and improved twist-lock connecting system.
- Leak-proof tested.
- Extra durable 304 stainless steel flue in Corn Vent (SPC).

SECURE VENT™

- Direct-vent system for free-standing gas stove and Direct Vent gas fireplaces.

DL

- Double-wall black stove connector for use with wood-burning stove listed to UL-641.
- Available in diameters of 6, 7 and 8 inches.



- Complete line of decorative and high-efficiency, EPA-approved wood-burning fireplaces.

Visit us at: www.SecurityChimneys.com